

Article number: 20343550M10KS
Description: E+G levelling foot
GN 343.5-50-M10-KS

Measures

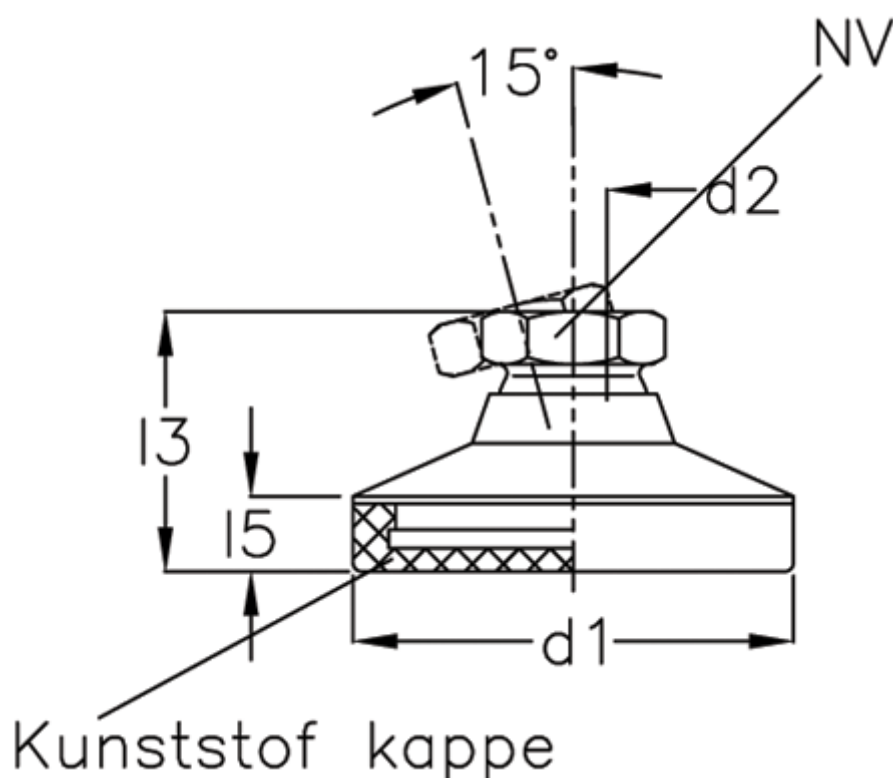

d1	= 50
d2	= 10
l3	= 29.5
l5	= 8.5
NV	= 15
Static load (N)	= 11
t min	= 10.5